



GOLDLINE GAS COOKTOP (SAB SERIES)

USER MANUAL



Built-in Gas Hobs

Installation and User manual

Content

Safety instructions	2
Product description	4
Specifications Table	6
Installation	8
Start Using your cooktop	13
Maintenance and troubleshooting	15
Servicing	19

Model numbers covered in this manual:

SAB301GL, SAB302GL, SAB2GL, SAB3GL, SAB402GL
SAB603GL, SAB4GL, SAB704GL, SAB5GL

NOTE: *This User Instruction Manual contains important information, including safety & installation points, which will enable you to get the most out of your appliance.*



This manual explains the proper installation and use of your appliance, please read it carefully before using even if you are familiar with the product. The manual should be kept in a safe place for future reference. In case of failure, only the Authorized Technical Service may repair this hob. Otherwise the guarantee will be null and void.

Warning

General safety

- The appliance may only be installed and connected by trained, Authorised persons.
- Built-in appliances may only be used after they have built in to suitable built-in units and work surfaces that meet standards.

In the event of faults with the appliance or damage to the glass toughened (cracks, scratches or splits), the appliance must be switched off and disconnected from the electrical supply, to prevent the possibility of an electric shock.

Repairs to the appliance must only be carried out by trained Authorised persons.

The technical and identification data for the hob figure on the reference plate fixed to the appliance.

This reference plate must be consulted before making the electrical connections.

- The electrical connections must be made by specialist aware to the legal and regulatory, requirements in each country.
- If the cable is damaged in any way it must be replaced by the manufacturer or after sale service or by authorized technical staff, to avoid hazard. Correct use
People (including children) who, because of their physical, sensory or mental capabilities or their inexperience or ignorance are not able to use the device safely, should not use this device without supervision or instruction by a responsible person.

This appliance should be used only for normal domestic cooking and frying of food.

The appliance must not be used as a work surface or as a storage surface.

Additions or modifications to the appliance are not permitted.

Do not place or store flammable liquids, highly inflammable materials or fusible objects (e.g. plastic film, plastic, aluminum, cardboard) on or near or below cupboards and drawers the appliance.

Do not heat an empty pan on the appliance.

Do Not Use this Appliance as Space Heater

We don't recommend after market lids or cover fitted with this product.

When the appliance is installed in a marine craft or in a caravan, it shall not be used as a space heater.

Do Not Modify This Appliance.

Children's safety

The cooking zones will become hot when you cook. Therefore, always keep small children away from the appliance.

The appliance is not intended for use by young children or infirm persons without supervision.

Young children should be supervised to ensure that they do not play with the appliance.

Safety during use

Remove stickers and film from the glass ceramic.

There is the risk of burns from the appliance if used carelessly.

Cables from electrical appliances must not touch the hot surface of the appliance or hot cookware.

Overheated fats and oils can ignite very quickly. Warning! Fire hazard!

Switch the cooking zones off after each use.

Users with implanted pacemakers should keep their upper body at least 30 cm from cooking zones that are switched on.

Risk of burns! Do not place objects made of metal, such as knives, forks, spoons and saucepan lids on the cooking surface, as they can get hot.





Safety Instructions and Product Description

Do not use or store flammable materials in the appliance storage drawer or near this appliance.

Do not spray aerosols in the vicinity of this appliance while it is in operation.

For LPG appliance:- **Do not use this appliance in a marine craft or caravan.**

This hotplate must be installed in accordance with: AS 5601 -Gas Installations (for Australia) NZS 5261 – Code of Practice for the Installation of Gas Burning Appliances and Equipment (for New Zealand) Local gas fitting regulations AS/NZS 3000 – Electrical Installations (Wiring Rules) Building codes Any other relevant statutory regulations.

Check the gas type label on the underside of the hotplate, adjacent to the gas connection to ensure it corresponds to the installation gas supply. If in doubt contact the supply authority.

The power supply cord (supplied) must not touch against any hot surfaces and must be placed so that its temperature does not exceed 75 degrees at any point along its length.

After connecting to gas, check for leaks using soapy solution, never a naked flame.

Where a flexible hose assembly is used, ensure it is approved to AS/NZS 1869, Class B or D. Any hose assembly used must be restrained from accidental contact with the flue outlet of an under bench oven. The hose is not to exceed 1.2m in length.

If you are required to transport the Goldline product to the Company or its service agent, you must ensure it is safely disconnected by a qualified tradesman and securely packed and insured. The Company does not accept any responsibility for loss or damage of the Goldline product prior to it being received by the Company or its service agent. Please dispose or recycle any packaging material.

How to avoid damage to the appliance

The glass toughened can be damaged by objects falling onto it.

The edge of the glass ceramic can be damaged by being knocked by the cookware.

Cookware made of cast iron, cast aluminum or with damaged bottoms can scratch the glass toughened if pushed across the surface.

Objects that melt and things that boil over can burn onto the glass ceramic and should be removed straightaway.

Do not use the cooking zones with empty cookware or without cookware.

To avoid damaging cookware and glass ceramics, do not allow empty saucepans or frying pans to keep heating by the hob.

The ventilation gap of 5mm between the worktop and front of the unit underneath it must not be covered.

Do not modify this appliance.

This unit is not designed to be used with any aftermarket lids or covers.

Safety when cleaning

For cleaning, the appliance must be switched off and cooled down.

For safety reasons, the cleaning of the appliance with steam jet or high pressure cleaning equipment is not permitted.

Disposing of the device When disposing of the device, do not bring it to regular municipal waste containers. Instead, bring it to electrical and electronic waste recycling and reuse center. A relevant label has been put on the device, its instructions manual, or the package. The device has been manufactured of recyclable material. By bringing old device to recycling collection center, you show that you care about nature. Ask your local environmental care authority for information on location of such facilities.



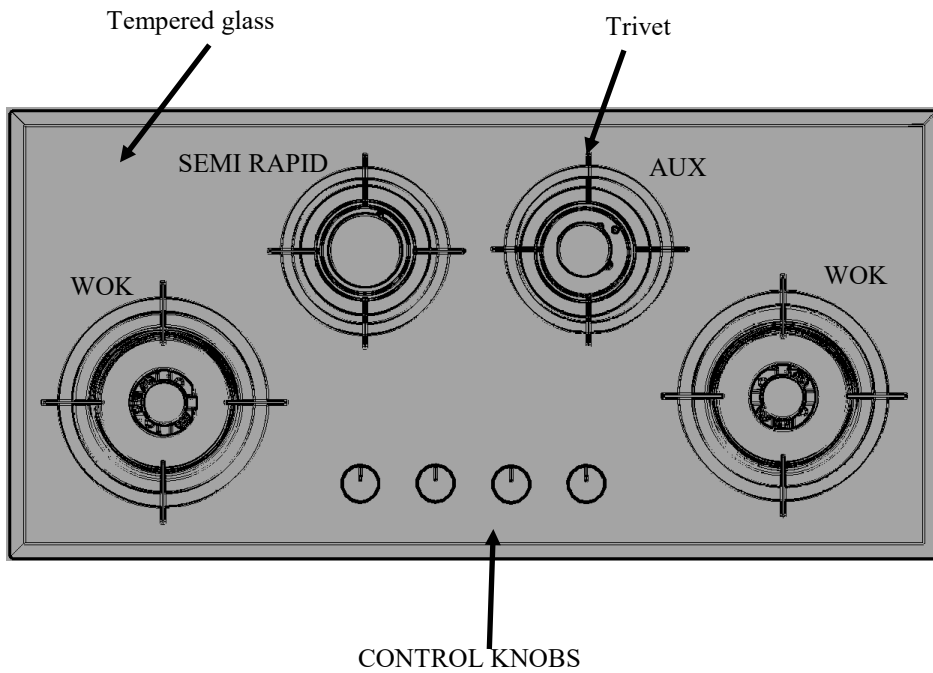



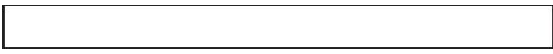

Model number. Shown
SAB4GL

Wok – Wok Burner
R – Rapid Burner
SR – SemiRapid Burner
Aux – Auxiliary Burner

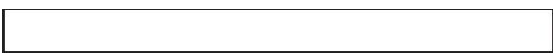
**Layout for different models will vary.
Please see SPEC table for burner details of each model.**

Accessory Name	Picture (for reference only, physical unit maybe different)	Quantity
User Manual		1
Installation clip		3
Screws ST4.2x18		3
Adhesive sealing tape		3
Natural gas regulator		1
Test point adapter		1

MODEL SPECIFICATION TABLE

Items	Unit	\$AB301GL	\$AB302GL	\$AB402GL	\$AB2GL	\$AB3GL	\$AB603GL	\$AB4GL	\$AB704GL	\$AB5GL
Ignition		DC1.5V Battery	DC1.5V Battery	DC1.5V Battery	DC1.5V Battery	DC1.5V Battery	DC1.5V Battery	DC1.5V Battery	DC1.5V Battery	DC1.5V Battery
DC/AC Top plate material	Type Reference	D	D	D	D	D	D	D	D	D
Glass colour		8mm toughen Glass	8mm toughen Glass	8mm toughen Glass	8mm toughen Glass	8mm toughen Glass	8mm toughen Glass	8mm toughen Glass	8mm toughen Glass	8mm toughen Glass
Glass Shape		Square	Square	Square	Square	Square	Rectangular	Rectangular	Rectangular	Rectangular
Nos. of hob		2	2	2	2	2	3	4	4	5
Gas type		NG/LPG/TG	NG/LPG/TG	NG/LPG/TG	NG/LPG/TG	NG/LPG/TG	NG/LPG/TG	NG/LPG/TG	NG/LPG/TG	NG/LPG/TG
Flame failure device		Yes	Yes	Yes	Yes	Yes	Yes	Yes	Yes	Yes
Gas pressure	Kpa	1.0/2.75/1.0	1.0/2.75/1.0	1.0/2.75/1.0	1.0/2.75/1.0	1.0/2.75/1.0	1.0/2.75/1.0	1.0/2.75/1.0	1.0/2.75/1.0	1.0/2.75/1.0
Gas inlet connection		Screw-1/2" BSP	Screw-1/2" BSP	Screw-1/2" BSP	Screw-1/2" BSP	Screw-1/2" BSP	Screw-1/2" BSP	Screw-1/2" BSP	Screw-1/2" BSP	Screw-1/2" BSP
Tray Depth	mm	43	43	43	43	43	43	43	43	43
Side clearance from the periphery of each burner to any combustible surface	mm	200	200	200	200	200	200	200	200	200
Clearance from base tray of cooker to its non-combustible material underneath	mm	50	50	50	50	50	50	50	50	50
Base tray	W x D mm	260x480	260x480	400x450	660x340	810x400	550x470	880x400	596x468	880x400
Top plate	W x D x H mm	300x530x4	300x530x4	530x450x4	750x450x4	890x460x4	640x500x4	930x450x4	640x500x4	930x450x4
Cut-out	W x D mm	265x485	265x485	405x455	665x345	815x405	555x475	885x405	601x473	885x405
Net weight	Kgs									





Bench cut out and cooktop dimension by model number.

See specs table on page 6 for details of bench cut out and other important information for each model.

The following is a guide to your installation layout.

According to Australian regulations, the minimum clearance between a gas cooktop element or burner component is:

- 600mm of vertical clearance to a combustible surface, and 200mm of horizontal distance to a vertical surface. If these measurements can't be met, the surface in question must be protected with a fire resistant material in accordance with **AG/601**.
- 600mm to a rangehood
- 750mm to an exhaust fan.

It's worth noting that with exhaust fans and rangehoods there isn't a specific clearance requirement under the Building Code of Australia. Like all appliances though, these need to be installed according to statutory requirements, and so that the installation meets the manufacturer's specifications.

The Standard also states that the horizontal clearance from a hotplate or burner to a vertical combustible material (like an acrylic splashback, for example) should be over 200mm. If not, the splashback or other material needs to be protected with a non-combustible material to a height of 150mm for the full length of the cooker.

2. Place burner box Apply the adhesive sealing tape to the underside lip of the burner box. Shown at G opposite. Place burner box into cutout hole and fit clamping brackets to clamp the hotplate to the bench.

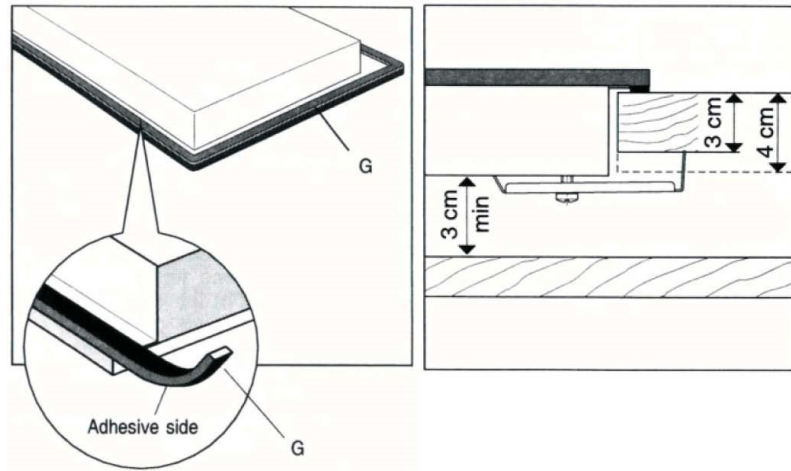

3. Fit burners and trivet. Replace burners and ensure they are correctly repositioned over the ignitor (S) and \ thermocouple (T). The ignitor (S) must be clean for trouble free sparking. Test burner ignition and burner flame for correct operation, If burner is placed correctly it will not rotate on its supports.. The DCC(Wok) burner(diagrams below) does not fit over the igniter or thermocouple but must be placed on its supports.

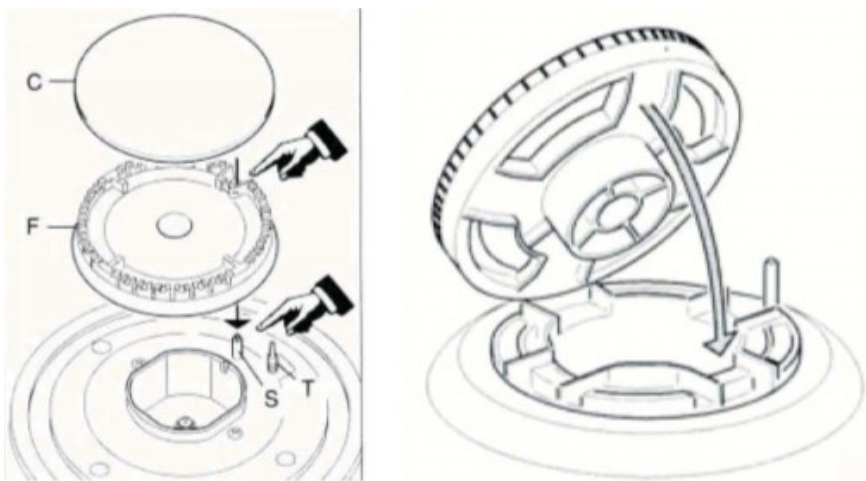

4. Electrical connection. Install a 10 amp general purpose outlet(GPO) in accordance with relevant electrical standards and/or codes of practice applicable. The power supply cord(supplied) must not touch against any hot surfaces and must be placed so that its temperature does not exceed 75° at any point along its length. After having installed the hotplate, the GPO must always be in an accessible position.

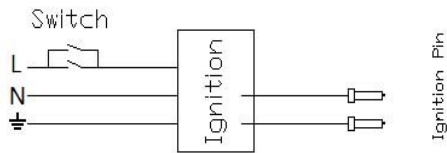

Wiring diagram for:
 SAB301GL,
 SAB302GL,
 SAB402GL
 SAB2GL

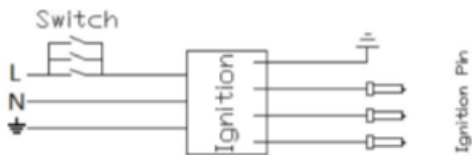

Wiring diagram for:
 SAB3GL
 SAB603GL

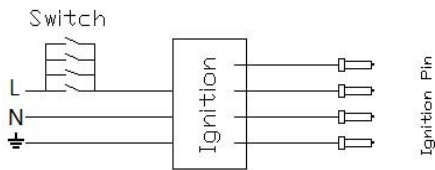

Wiring diagram for:
 SAB4GL,
 SAB4GLH,
 SAB704GL,

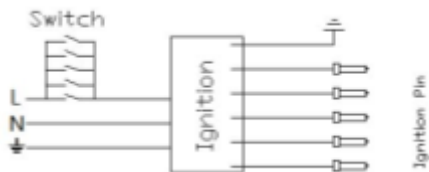

Wiring diagram for:
 SAB5GL

5. Gas connection

Install in accordance with relevant gas standards and/or codes of practice applicable. Connect the elbow fitting to the appliance gas manifold connection, and check that seals between the elbow and manifold connection are in place and in good condition.

For Natural gas : connect the natural gas appliance regulator (pictured opposite) with integral test point using approved gas thread tape or compound to the elbow fitting.

For Universal LPG : connect the Test point adapter (pictured below) with integral test point using approved gas thread tape or compound to the elbow fitting.

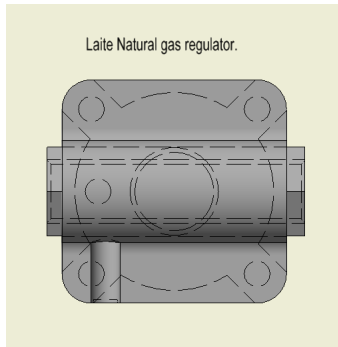

Natural Gas Regulator



LPG testpoint

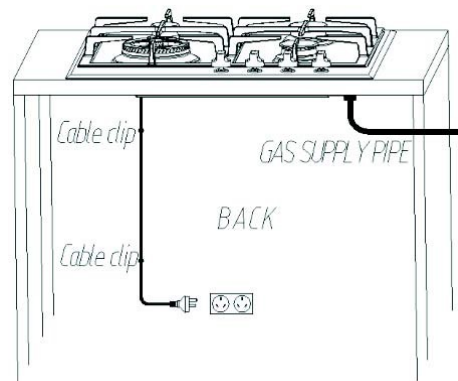
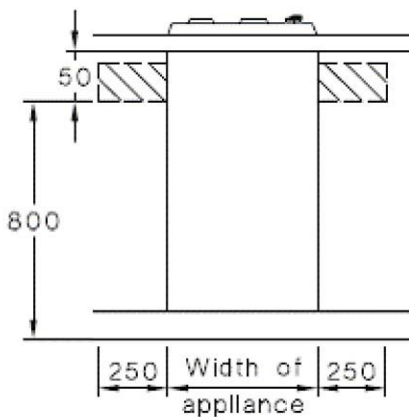

Ensure the supply connection point, test point and natural gas regulator adjustment screw (for Natural gas installation) are accessible for testing and/or adjustment with the hotplate in the installed position. Where a flexible hose assembly is used, ensure it is approved to AS/NZS 1869, Class B or D with max. length of 1.2m. Any hose assembly used must be restrained from accidental contact with the flue outlet of an under bench oven. This hose assembly shall be suitable for connection to a fixed consumer piping outlet located as follows: Hotplates at a point 800 mm to 850 mm above the floor and in the region outside the width of the appliance to a distance of 250 mm.

Note: If clearance between side and rear walls and periphery of the burner is less than 250mm, the walls must be protected with a non-combustible material. The protection must extend a minimum distance of 450mm above the burner. Horizontal surfaces less than 650mm vertically above the hotplate must also be protected.





i
n
l
e
t
c



After connecting to gas, check for leaks using soapy solution, never a naked flame. Fit the duplicate data plate (supplied in separate bag) on a surface adjacent to the hotplate, for example, the inside of the cupboard door so it is clearly visible for any service technician.

SETTING THE GAS PRESSURE : Fit a manometer with a 6 mm rubber hose to the test point on the regulator (for natural gas). For all the models, light all burners on and adjust test point pressure to 1.00 kPa. Turn burners off and on again and recheck the pressure is same as set previously or adjust as required. **TEST FOR CORRECT OPERATION :** After installation and test point setting, each burner ignition and operation must be tested individually and with all burners operating. This testing must be done by the installer before leaving.

ADJUSTING THE BURNER MINIMUM FLAME HEIGHT : **NOTE:** This adjustment can only be performed by authorised service personnel. The minimum burner flame is factory adjusted for the gas type stated on the gas type label adjacent to the gas connection and should not require adjustment. Adjustment may be required if the hotplate has been converted from Natural gas to Uni-

Description	Explanation
 Zone indicators	These show which zone is under control.
 Flame power	Flame power of the zones,  is the lowest and  is the highest.

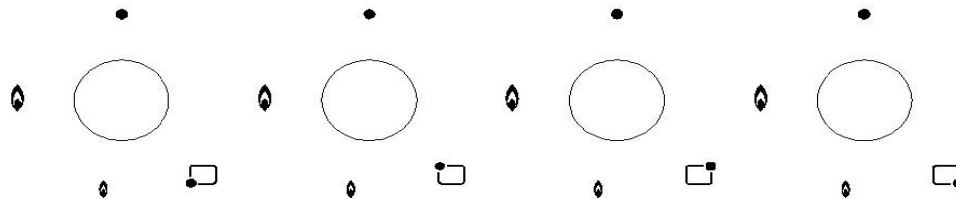

The hotplates are fitted with mains powered electronic spark igniters, so must be connected to mains power supply (i.e. nominal 220 -240 V ac) to operate. If power is not available, the hotplate will still work but the burners will have to be lit with a match or similar. Depressing the gas control knob of any burner will activate the spark ignition for all burners. To light the burner, turn the gas control knob to the High Flame setting of the burner to be lit, while at the same time depressing the gas control knob to activate the spark ignition. Once the burner is alight continue to depress the gas control knob for 5 – 10 seconds to allow the flame safeguard to activate. If when you release the gas control knob, the burner flame goes out the flame safeguard has not heated up enough so repeat the ignition procedure after waiting 1 minute for gas to disperse. If problems with burner lighting persist, refer to the TROUBLESHOOTING section of these instructions. If power is not available, light a match or similar, then turn the gas control knob for the burner to be lit, to the High Flame setting. Once again if problems with burner lighting persist, refer to the TROUBLESHOOTING section of these instructions. When burner lights, adjust desired

BURNER AND UTENSIL CHOICE

The maximum utensil (pan) diameters in millimetres (mm) for each burner are:
For Natural Gas hotplates

Auxiliary (small) and Semi-Rapid (medium) = 195 mm

Rapid (large) = 230 mm

DCC (wok) = 400mm

For Universal LPG hotplates

Auxiliary (small), Semi-Rapid (medium) and Rapid (large) = 195 mm

DCC (wok) = 270 mm

The minimum utensil (pan) diameters in millimeters (mm) for each burner are:

Auxiliary (small)=80 mm

Semi rapid (medium)= 140mm

Rapid (large) and Triple ring (wok)= 195mm

For the best efficiency and to ensure utensil handle does not over heat, place the utensil centrally on the burner and adjust the flame height so all the flame remains under the utensil.



Do not place anything, eg. flame tamer, asbestos mat, between pan and pan support as serious damage to the appliance may result.



Do not remove the pan support and enclose the burner with a wok stand as this will concentrate and deflect heat onto the hotplate.



Do not use large pots or heavy weights which can bend the pan support or deflect flame onto the hotplate.



Locate pan centrally over the burner so that it is stable and does not overhang the appliance.



Use only a wok support supplied or recommended by the manufacturer of the appliance.

NOTE: Enclosure may be circular or square

Cleaning and maintenance should be carried out with the appliance cold, especially when cleaning the enamel parts. Avoid using alkaline or acid substances (lemon juice, vinegar etc..) on the surface.

CERAMIC GLASS PANEL

The ceramic glass hob of the hotplate must be cleaned regularly (e.g. weekly) to ensure long life expectancy of the hot plate.

Ensure the hot plate has cooled. Wash down with warm soapy water and rinse with clean water.

Dry with a warm cloth.

NOTE: Ensure that wiping is done along the grain of the ceramic glass top to prevent any unsightly crisscross scratching patterns from appearing.

TRIVETS (UTENSIL SUPPORTS)

Enameled parts must only be washed with a sponge and soapy water or with non-abrasive products. Rinse with clean water.

Dry with a clean dry cloth.

BURNERS

Remove trivets from hob. Ensure that burners are cool. Remove the burners enameled cape and aluminum burner crown (F)

Wash down with warm soapy water and rinse with clean water.

Dry with a clean dry cloth.

Use a cotton bud, toothbrush or some other similar item to clean out any incrustations or dirt from the four holes marked (H)

Replace burners and ensure they are correctly repositioned over the igniter (S) and thermocouple (T). The igniter (S) must be kept clean for trouble free sparking. Test the burner ignition and burner flame for correct operation.

The DCC (wok) burner (bottom diagram) does not fit over the igniter to thermocouple for positioning but must be placed on its supports.

If the burner is in the correct position it will not rotate.

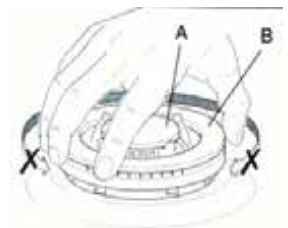
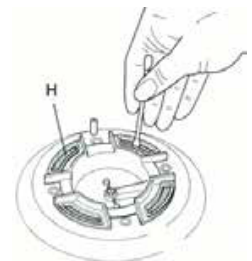
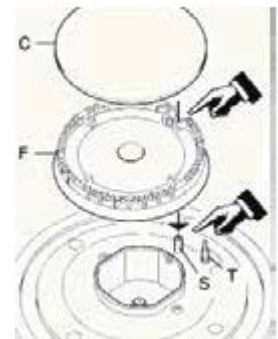



Before Installation :

Before cutting into any bench tops, ensure the minimum clearances to walls, adjacent surfaces and overhead surfaces required by the relevant gas appliance installation code (see above) will comply. Dimensions are specified in millimeters (mm)

Overhead cupboards and range hood = 600 mm. Side and rear clearance = 200 mm to any burner edge. Overhead exhaust/When you have installed the hob, make sure that

The GPO (general purpose outlet) must always be in an accessible position.

The supply connection point, test point and natural gas regulator adjustment screw (for Natural gas installation) are accessible for testing and/or adjustment with the hotplate in the installed position.

TO BE INSTALLED ONLY BY AN AUTHORIZED PERSON

Place burner box Apply the adhesive sealing tape to the underside lip of the burner box. Shown at G opposite. Place burner box into cutout hole and fit clamping brackets to clamp the hotplate to the bench.

Electrical connection. Install a 10 amp general purpose outlet(GPO) in accordance with relevant electrical standards and/or codes of practice applicable. The power supply cord(supplied) must not touch against any hot surfaces and must be placed so that its temperature does not exceed 75 degree at any point along its length. After having installed the hotplate, the GPO must always be in an accessible position.

GAS CONVERSION INSTRUCTIONS:

The manufacturers servicing instructions detail how authorized personnel may convert the hotplate from Natural gas to LPG or from LPG to Natural gas. Contact the manufacturer or agent as required.

Converting to a different gas type

When converting from LPG to NG ensure that the LPG test point is removed and replaced with an approved NG regulator supplied in the kit. The test point pressure must be adjusted to 1.00 kPa with the largest burner operating at on maximum flame.

Table of injector sizes.

GAS TYPE	WOK (OUTER)	WOK (INNER)	SEMI RAPID	AUXILIARY
LPG	1.10	0.50	0.69	0.50
NG	1.80	0.8	1.18	0.9
HKTG	3.00	1.45	1.75	1.30

Changing the jets:

1. Remove pan supports, burner heads and cups.
2. Use a 7mm socket to unscrew and remove the jets, replacing them with those supplied in the kit. Ensure that the correct jets are fitted to the corresponding burner (see spec table)
3. Fit the gas type label supplied with this kit next to the gas connection point and remove existing label.

Setting the minimum flame level:

1. Remove panels, knobs and water dish.
2. Reassemble the burner heads, caps and knobs.
3. Light one of the burners and turn the tap to maximum flame.
4. Use a thin blade screwdriver to turn the by-pass screw located on the right of the gas tap shaft as show in the image on the right.
Turn the by-pass screw fully counter clockwise. The result should be a small, stable flame which is uniform around the entire burner ring, if not turn the by-pass screw clockwise until satisfied with the flame.
5. Check that the burner does not go out when the tap is turned quickly from the maximum to minimum position.
6. Repeat for each burner.
7. Remove the burner heads caps and knobs
8. Reassemble panels, burner heads, caps, knobs and pan supports.

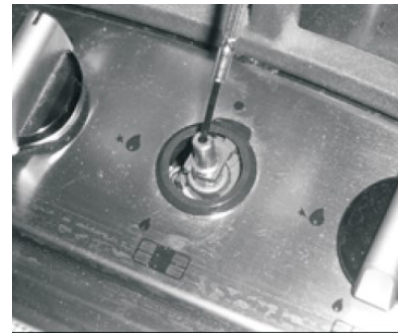

Gas Conversion (NG to LPG)

If the required gas conversion kit is not supplied with your appliance, Gas conversion shall only be undertaken by an authorized person.

The NG to LPG conversion kits contains:

- Test point adaptor
- Auxiliary jet dia 0.50mm
- LPG gas type label
- Semi rapid jet dia 0.65
- Wok jet dia 0.5mm (Inner) + dia 1.10mm (Outer)

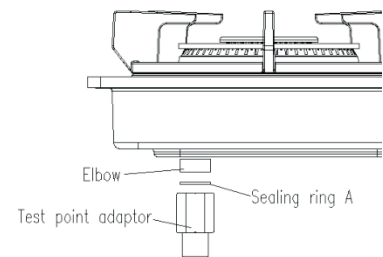

LPG gas inlet connection

GAS CONVERSION (LPG TO NG)

If the required gas conversion kit is not supplied with your appliance, you can order one from GOLDLINE.

Gas conversion shall only be carried out by by an authorized service technician.

The conversion kit contains:

- NG regulator
- NG Gas type label
- Auxiliary jet dia 0.9mm
- semi Rapid jet dia 1.1mm
- Wok jet dia 0.8mm ineer and 1.8mm outer



TROUBLESHOOTING

Servicing of the hotplate must only be done by an authorized service representative (see back of this booklet) and the hotplate must not be modified. Power must be disconnected before any servicing or maintenance is conducted.

Abnormal conditions include:

- Excessively yellow or sooting flame type.
- Flame lifting off the burner ports.
- Flame lighting back into the burner (normally associated with a popping sound)
- Objectionable odour of the flames combustion products.

Should a faulty condition develop in the hotplate that is not described above, refer to the following table first for possible causes and remedies prior to contacting an authorized service representative. Servicing beyond the remedies listed shall only be undertaken by an authorized service representative.

FAULT ISOLATION CHART

FAULT	CAUSES	REMEDY
Burner will not light	1. Air in gas line 2. Blockage in line 3. Ignition not sparking 4. Flame failure device faulty 5. Check the battery (applicable to DC version)	1. Purge gas line 2. Trace back and clear 3. Check lead and electrode 4. Replace thermocouple and test 5. Replace the battery
Burner lights back to injector	1. Excessive lint up burner mixing tube 2. Excessive gas pressure	1. Remove and clean burner 2. Check gas regulator pressure. Adjust if necessary.
Burner has explosive ignition	1. Excessive gas pressure	1. Check gas regulator pressure. Adjust if necessary.
Ignitor not sparking	1. Electrode gap 2. Ignition connection	1. Check gap, adjust if not between 4-5mm 2. Check connection to ignitor, replace if faulty.



SERVICING INSTRUCTIONS

WARNING! DANGER 240
VOLTS 50Hz.

DISCONNECT POWER BEFORE SERVICING UNIT DO NOT
MODIFY THIS APPLIANCE

MINOR ADJUSTMENT

Access to By Pass Screw

- Light the burner and turn to minimum setting (marked small flame).

The flame should

minimum setting and should not extinguish when passing from maximum setting to low setting.

- If adjustment is necessary, remove the control knob by pulling upward. The bypass screw is accessible

via the control knob spindle. Turn

the bypass screw anti-clockwise to increase the turn-down rate

Access to manifold, gas taps and burner assembly

- Remove glass hob and control knobs.

- To remove gas cocks. Unscrew the locking nut (between cock and burner). Remove screws, the cock can now be removed from the manifold.

If access to the barrel is required, remove two screws, which retain spindle to body. If lubricating the mechanism use Regosine Moly LM or other approved grease.

To replace electrode

- Remove screw from the clamp holding the electrode and thermocouple and note the

adjustment setting height of each. Replace electrode and then fit clamp and screw.



WARRANTY

1.1 In this warranty:

1.1.1 Australian Consumer Law means the law as set out in Schedule 2 of the Competition and Consumer Act 2010;

1.1.3 Consumer means a “consumer” as that term is defined in Section 3 of the Australian Consumer Law as the original purchaser of a Goldline product;

1.1.4 Consumer Guarantees means the guarantees under the Australian Consumer Law;

1.1.5 You means the Consumer.

1.2 Nothing in this warranty affects any person’s rights under the Australian Consumer Law. The benefits to any Consumer under this warranty are in addition to the rights and remedies available under any Consumer Guarantees.

1.3 Subject to the other clauses of this warranty, the Company warrants to the Consumer that the Goldline product will be free of manufacturing defects and will perform to the Company’s specifications.

1.4 The benefit of this warranty extends only to the Consumer as original purchaser of a Goldline product which is installed in a residential property.

1.5 This warranty commences on the date of purchase of the Goldline product by the Consumer and continues for the benefit only of the Consumer until the expiry of two (2) years (Warranty Period) .

1.6 If within the Warranty Period a manufacturing defect is discovered in the Goldline product or it fails to perform to the Company’s specifications as a result of some defect in materials, components or workmanship (Defect) then the Company will, at its option, repair the Goldline product or supply a replacement Goldline product free of charge. A replacement Goldline product may differ from the original product purchased by the Consumer.

1.7 This warranty will not apply to any Goldline product:

1.7.1 Installed by any person other than a qualified tradesperson; or

1.7.2 Subjected to misuse, neglect, negligence or accidental damage; or

1.7.3 Operated in any way contrary to any operating or maintenance instructions; or

1.7.4 Improperly handled, installed or maintained; or

1.7.5 Altered or modified prior to or after installation; or

1.7.6 Damaged directly or indirectly by power surges, electrical storm damage or connection to incorrect power supply

Australian Consumer Law requires the inclusion of the following statement with this warranty:

Our goods come with guaranteed that cannot be excluded under the Australian Consumer Law . You are entitled to a replacement or refund for a major failure and for compensation for any other reasonably foreseeable loss or damage . You are also entitled to have the goods repaired or replaced if the goods fail to be of acceptable quality and the failure does not amount to a major failure.

IN ORDER TO MAKE A CLAIM UNDER THIS WARRANTY, THE CONSUMER MUST CALL GOLDLINE - 03 9799 9660 (AUSTRALIA) TO CONNECT TO THE NEAREST AUTHORISED CENTRE



WARRANTY (CONT)

1.8 You must provide proof of your purchase of the Goldline product and the date of purchase in order to obtain the benefit of this warranty.

1.9 If you live outside the service area of the Company or one of its service agents, this warranty does not cover the cost of transport of the Goldline product for service nor the service agent's traveling costs to and from your home.

1.10 If you are required to transport the Goldline product to the Company or its service agent, you must ensure it is safely disconnected by a qualified tradesman and securely packed and insured. The Company does not accept any responsibility for loss or damage of the Goldline product prior to it being received by the Company or its service agent.

1.11 You will be responsible for all costs of returning a Goldline product to the Company and for redelivery of the Goldline product by the Company (whether it is the original or a repaired and/or a replacement Goldline product) and for any other expenses you incur in claiming under this warranty.

1.12 The Company or its service agent will examine any Goldline product and if the Company determines that it is defective through no fault of the Owner and is otherwise undamaged, the Company will repair or replace the Goldline product in accordance with this warranty.

DO NOT SEND IN THIS WARRANTY

Fill out the following details and file with your purchase invoice. RETAIN & FILE WITH YOUR RECEIPT Your Purchase Receipt/Invoice is proof of date of purchase. If you are unable to establish the date of purchase, or if the fault is not covered by this warranty, or if the product is found to be in working order, you will be required to bear all service call charges. Company name Goldline reserves the right to discontinue items, modify designs and change specifications without incurring obligation. Whilst every effort is made to ensure that descriptions, specifications and other information in this publication is correct, no warranty is given in respect thereof and the company shall not be liable for any errors therein.

To register your product you need below details. Please visit Goldline website.

For customer record.

Place of purchase:

Company name:

Address:

Date of purchase:

Serial number:

Model number:

NOTE: Consistent with our continuing product development policy, improvements may have been made which render the contents of this packaging slightly different to that shown.

FOR WARRANTY SERVICE CALL GOLDLINE (+61) 03 9799 9660 TO CONNECT YOU TO YOUR NEAREST AUTHORIZED SERVICE SUPPLIER.