

CHOICE SUPPLIES



BATHROOM • KITCHEN • LAUNDRY

Yukon Toilet Suite

Features

Product Code - 131150313

Labour Warranty - 1 Year

Ceramic Warranty - 5 Years

S-Trap - 60 - 180mm

P-Trap - 180mm

Soft Close / Quick Release Seat

Comes with Chrome button

Custom Colour Buttons Available



Brushed Nickel



Matt White



Matt Black



Brushed Gold



Chrome



Gun Metal

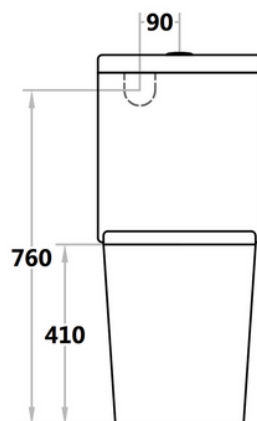
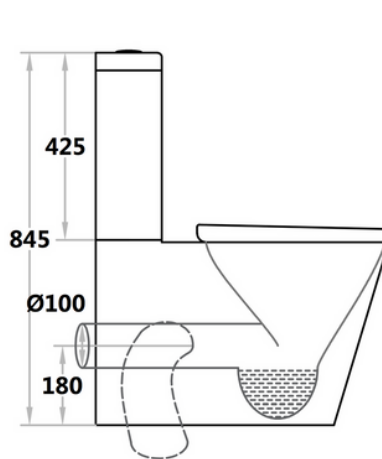
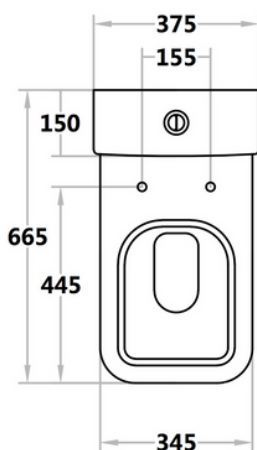





2/820 Princes Hwy, Springvale VIC 3171
P: (03) 9548 1033 | info@choicesupplies.com.au
www.choicesupplies.com.au

INSTALLATION

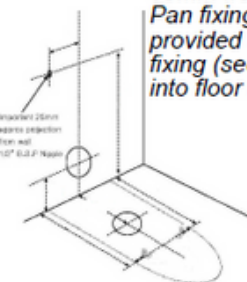
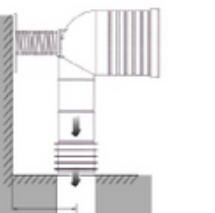
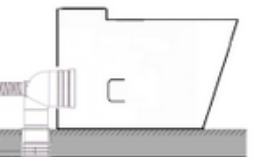
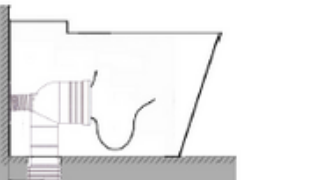
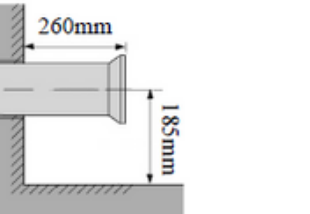
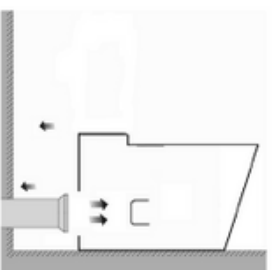

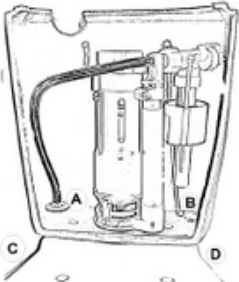
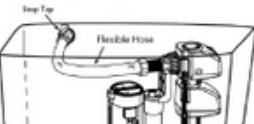
Note: All measurements for roughing-in should be taken from finished wall/floor. **Installation of this product is to be performed by a licensed plumber.**

<p>1 Rough in position of water inlet, waste outlet. Ensure inlet connection extends 60mm from finished wall. <i>Pan fixing brackets are provided as an optional extra fixing (see step 7), drill holes into floor now if required.</i></p>  <p><i>For detailed measurements, please refer to the above specification</i></p>	<p>2 Lubricate the fins of the pan bend and position into waste pipe.</p> 	<p>S-Trap</p> <p>3 Lubricate rubber on the exposed connector end</p> 	<p>4 Align and push the pan back onto the wall</p> 
<p>5 Set up waste pipe so that the end of the pan collar extends 260mm from the finished wall.</p> 	<p>P -Trap</p> <p>6 Align and push the pan back to the wall, connecting pan spigot to pan collar. Bucket flush and check for leaks.</p> 	<p>7 Place rubber seal into pan recess. (DO NOT USE SEALANT).</p> <p>Place cistern screws into holes on the inside of cistern, making sure washers are located correctly. Gently lower cistern onto pan locating fixing screws into matching pan screw holes. Secure cistern to pan. Before tightened fully, make sure the cistern sits square and straight to pan.</p>  <p>Connect pan fixing to brackets if installed at step 1.</p> <p><i>Due to the design, weight, and stability of the pan and cistern a silicone adhesive only is recommended and excepted by manufacturer for floor based fixing.</i></p>	
<p>8</p>  <p>IF BACK INLET, SKIP THIS STEP. Remove cap from cistern plug A or B at base cistern. Connect flexible hose to cistern plug A or B depending on location of stop tap. Complete stop tap connection to underside of cistern plug C or D. Fill cistern and ensure correct water level.</p> <p>Note: Inlet valve can be adjusted if required.</p>	<p>9 IF STEP 8 IS COMPLETED, SKIP THIS STEP. Fit off stop tap then connect rear water inlet valve to stop tap. Fill cistern and ensure correct water level.</p> 		<p>Make sure inlet valve flow are free from side of cistern wall. If inlet valve been jam on the cistern wall, it will cause inlet valve keep filling.</p>  <p>Installation of Toilet Seat and Cleaning It is recommended that toilet seat and cover be installed after all trades are finished</p>

Cleaning Recommendations

The high quality vitreous china finish on all sanitary ware can be maintained by simply using mild soapy water and wiping over. Sanitary ware should not be cleaned with abrasive materials e.g. steel wool/scourers. Do not use any corrosive or abrasive cleaning agents containing acids or scouring agents as this may lead to surface damage. Bleaches can also discolour seats and hinges and therefore should not be used. If your toilet has metal hinges they should only be cleaned with a mild liquid domestic cleaner, with soft soapsuds or Steel & Chrome cleaner. After cleaning, rinse with clean water and polish with a clean soft cloth.

Warranty Detail

Vitreous China: 15 Year Ceramic Warranty - 12 Months Labor.

Mechanism: 3 Year Replacement Warranty - 12 Months Labor

Seat: 1 Year Replacement Warranty

2/820 Princes Hwy, Springvale VIC 3171
P: (03) 9548 1033 | info@choicesupplies.com.au
www.choicesupplies.com.au